

Wi-Fi Card/Box

User's Manual

Table of Content

1	Overview.....	1
1.1	Introduction.....	1
1.2	Features.....	1
1.3	Product overview.....	2
2	Preparation	3
2.1	Prerequisite	3
2.2	Installation.....	3
3	Wi-Fi Card Configuration	4
3.1	Quick Configuration	4
3.2	Pin Configuration	5
3.3	Access embedded webserver in STA (Station) mode.....	5
3.4	Embedded webserver	6
4	Monitor.....	14
4.1	Registration	15
4.2	Login.....	16
4.3	Location Manager	19
4.4	Device Manager	21
4.5	Monitor	22
4.6	User Manager	27
4.7	Email Notification	30
5	Trouble Shooting	32
5.1	Frequently Asked Questions.....	33

1 Overview

1.1 Introduction

The Wi-Fi card will collect data from connecting inverter(s), and transmit data to online data center via wireless network. The HTTP service of data server can monitor several devices, and can store all data/events in the data server. After installing the Wi-Fi card, users can configure the communication parameters as AP mode (Access Point) or remotely accessing the inverter data through the internet as STA mode (Station Mode). Users can access inverter operation data, and analyze problems with through the web browser. This Wi-Fi card will automatically update/install the latest firmware.

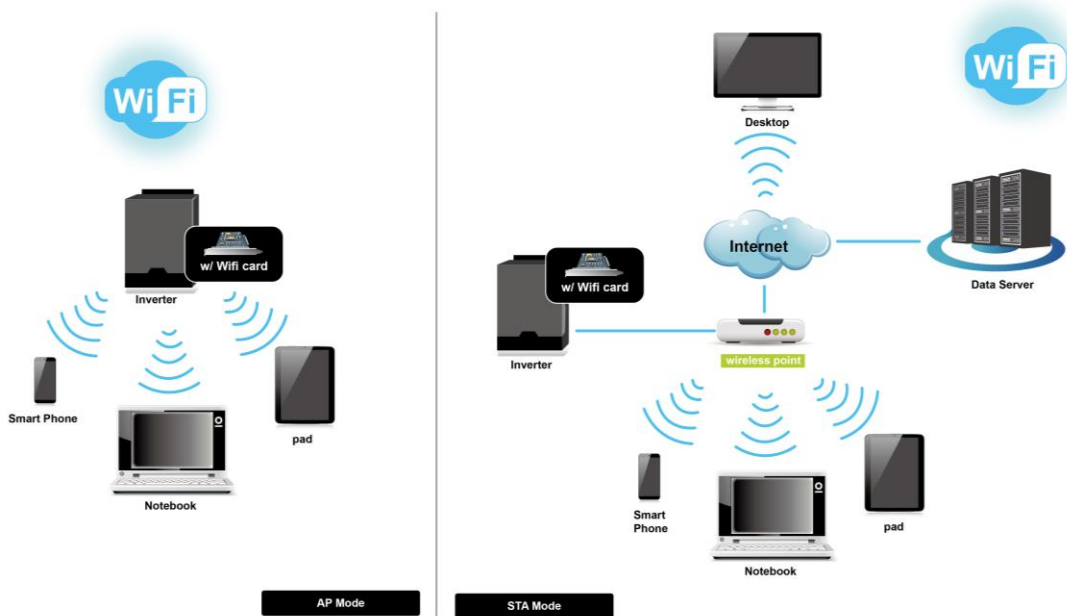

Diagram 1-1

1.2 Features

- Upload information to data server via wireless network
- Remotely monitoring inverter(s) data through the data server at any time
- Event Notification via Email
- Built-in web server
- Automatic firmware upgrade

1.3 Product overview

- WiFi card



- WiFi box

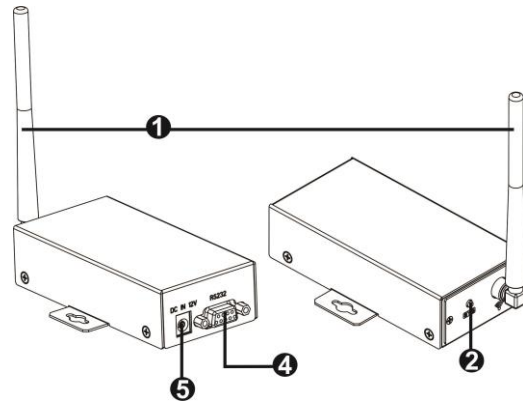

- ❶ Antenna
- ❷ System status LED
- ❸ Golden Fingers: to connect intelligent slot of connected device
- ❹ RS-232 port
- ❺ 12Vdc DC input

System Status LED:

LED Status	Description
Off	Power off or internal fault
500ms on , 500ms off	Internet is not available.
100ms on , 2900ms off	Communication error with monitored device
100ms on , 100ms off	In the process of uploading data to data center
On	Wi-Fi card is operating normally.

1.4. Package Contents



Before installation, please inspect the unit. Be sure that nothing inside the package is damaged during transportation. You should have received the following items inside of package.

Wi-Fi Card Package	Wi-Fi Box Package
<ul style="list-style-type: none"> ● Wi-Fi card ● Antenna ● User's manual ● Screws x 2 pieces 	<ul style="list-style-type: none"> ● Wi-Fi box ● Wi-Fi card ● Antenna ● User's manual ● RS-232 cable

2 Preparation

2.1 Prerequisite

The following devices are required if you're using Wi-Fi Card or Wi-Fi Box:

	
For Wi-Fi Card: <ol style="list-style-type: none">1. Wi-Fi card2. Wireless access point3. Monitored device	For Wi-Fi Box: <ol style="list-style-type: none">1. Wi-Fi Box2. Wireless access point3. RS-232 cable4. Power input cable (12Vdc)5. Monitored device

2.2 Installation

For Wi-Fi Card:

1. Attach the Antenna to Wi-Fi card.

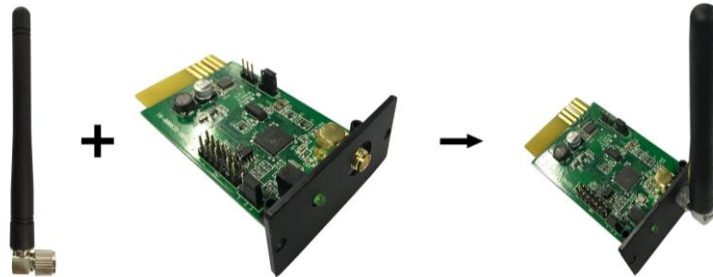

2. Remove the Intelligent Slot cover located on the Inverter. Insert Wi-Fi card into the slot and secure it with screws.

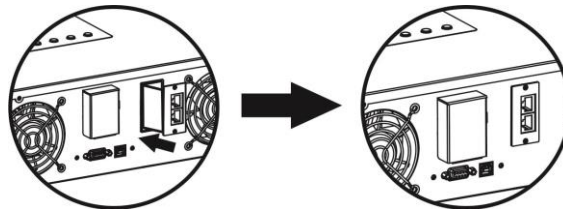

For Wi-Fi Box:

1. Attach the Antenna to Wi-Fi box.
2. Connect DB9 terminal of RS-232 cable to the Wi-Fi Box.
3. Connect the other end of RS-232 cable to the Inverter.
4. Use one input power cable to connect to ⑤ of Wi-Fi Box.

3 Wi-Fi Card Configuration

3.1 Quick Configuration

- a) If using the Wi-Fi box, please connect it to a power adapter.
- b) Using device such as cell phones or laptops to connect to access point named "wificard". The password is "open".
- c) Open your browser. Enter "wificard.net" or "192.168.1.1" to access control panel.
- d) Click on "Application Config". Configure "Time Zone" and "Daylight saving time". Then, click "Apply" button.

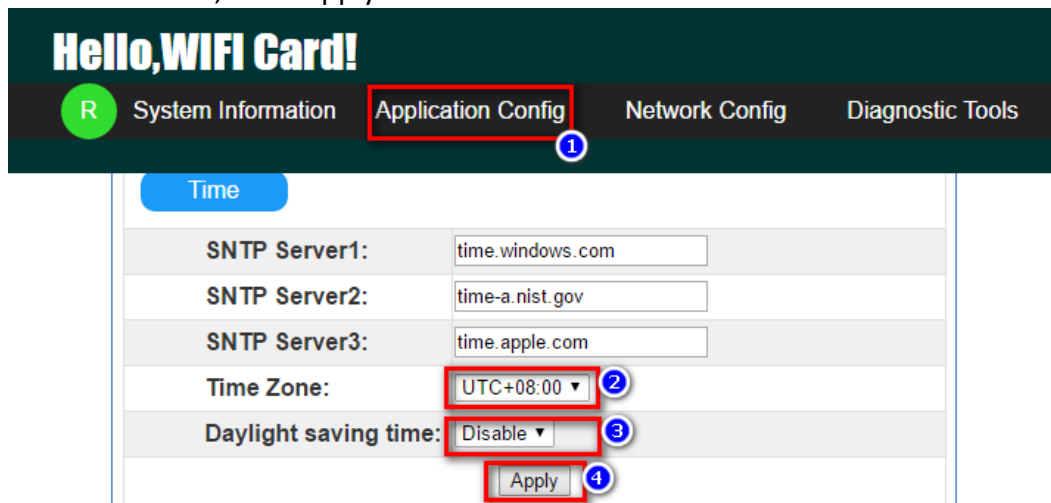

- e) Click on "Network Config". Enter Wi-Fi card information under "Add Profile" area and click on "Add" button to save. All entered data will be listed under STA Profiles.



- f) In Device Role area of the same page, choose “Station” in the Mode column and click on “Apply” button. Power cycled the Wi-Fi card after 5 seconds to put your setting into effect.

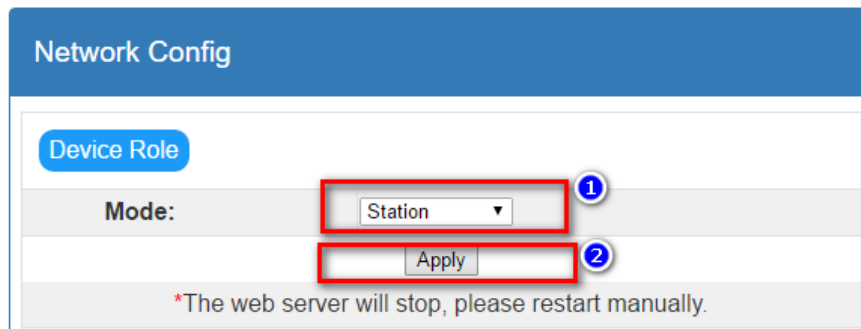

3.2 Pin Configuration

Adjust the UC2 jumper pin from “1,2” to “2,3” position to restore to factory setting. After restoring to factory setting, Wi-Fi card will work in AP (Access Point) mode, SSID (Wireless Network Name) is “wificard” and the password is “open”. After restoring back to factory setting, it’s necessary to return the jumper to “1,2” position. Otherwise, the Wi-Fi card will be restore back to factory setting after reset.

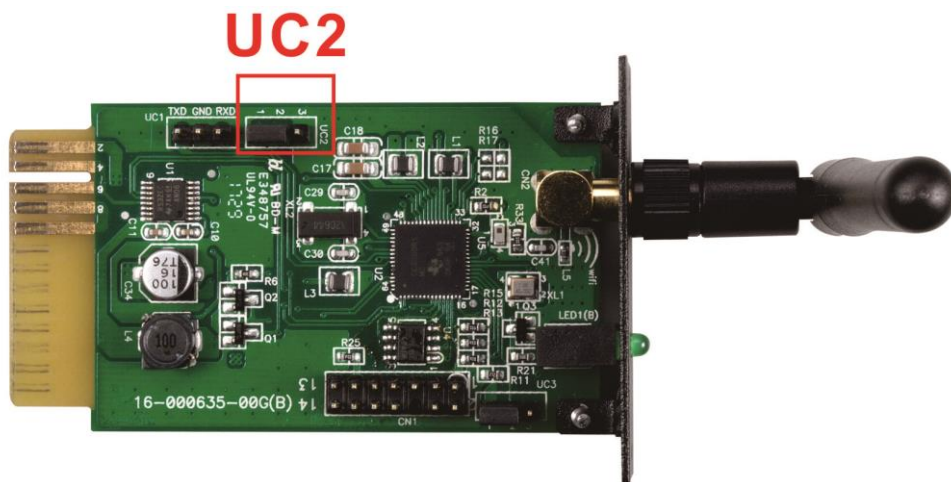

Pin	Default position	Function
UC2	1,2	1,2: Normal operation 2,3: Restore to factory setting

3.3 Access embedded webserver in STA (Station) mode

Enter the current IP address of Wi-Fi card in the browser to access the embedded webpage under “Station” mode.

3.4 Embedded webserver

In the web server menu, there are five main functions:

- Green R Button: restart Wi-Fi card.
- System Information: display current status of Wi-Fi card.
- Application Config: Itemize Wi-Fi card parameters.
- Network Config: Network configuration setting including AP and STA mode.
- Diagnostic Tools: Ping testing tool for network connection analysis.

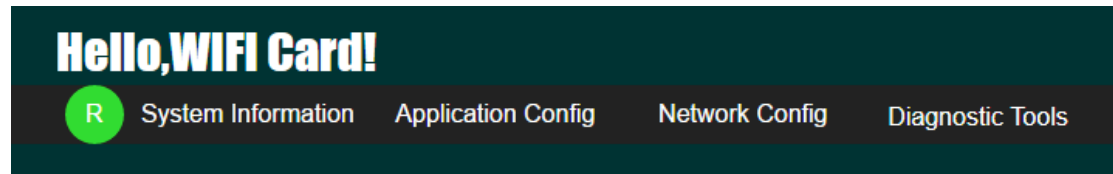

System Information	
Status	
Upload:	✓ Tx:00024 Rx:00024
UART:	✓ Tx:03430 Rx:01369
Device	
Device Name:	wificard
Device ID:	WIFICARDTEST001
Device Mode:	Station
System Time:	2017-10-23 15:50:45
System Up Time:	0 days 00:27:29
Network	
MAC Address:	8C:8B:83:D3:4E:D5
AP SSID:	wificard
AP Security Type:	Open
AP Domain Name:	wificard.net

3.4.1 System Information

System Information	
Status	
Upload:	✓ Tx:00027 Rx:00027
UART:	✓ Tx:04340 Rx:01732

Status: Displays upload and UART communication status

- Upload: Data upload status from Wi-Fi card to data server through http protocol. Tx represents the number of upload times from Wi-Fi card. Rx represents the number of response times from data center. It also means the number of times to successfully upload data. The number will reset to zero when it reaches 65535.
- UART: Communication status between Wi-Fi card and monitored device. Tx represents the number of times data sent from Wi-Fi card. Rx represents the number of times commander received. The value of Rx may be much smaller than the value of Tx. The number will reset to zero when it reaches 65535.

Device	
Device Name:	wificard
Device ID:	WIFICARDTEST001
Device Mode:	Station
System Time:	2017-10-23 15:59:05
System Up Time:	0 days 00:35:48

Device: Displays relative information of the Wi-Fi card.

- Device ID: Wi-Fi Card serial number. It identifies the Wi-Fi card in the data server.
- Device Mode: Current working mode. (Access Point or Station Mode)
- System Time: Current time on the Wi-Fi card. The format is YYYY-MM-DD HH:MM:SS.
- System Up Time: Represents operational hours since initialization of the Wi-Fi card. The format is X days HH:MM:SS.

Network	
MAC Address:	8C:8B:83:D3:4E:D5
AP SSID:	wificard
AP Security Type:	Open
AP Domain Name:	wificard.net
AP IP Address:	192.168.1.1
STA DHCP State:	Enabled
STA IP Address:	0.0.0.0
STA Subnet Mask:	0.0.0.0
STA Gateway:	0.0.0.0
STA DNS:	0.0.0.0

Network: Shows internet configuration including AP and STA modes.

- AP SSID: Wi-Fi Card SSID under AP mode.
- AP Domain Name: Enter name to access the web interface under AP mode.
- STA IP Address: Enter IP address to access the web interface under STA mode. This address is only effective when STA DHCP State is disabled.

Application	
FW Version:	1.0.0
FW Timestamp:	20171023131900
HTML Timestamp:	20171023131900

Application:

- FW Version: Firmware version of the Wi-Fi card.
- FW Timestamp: Time stamp for the firmware. It could be use to verify firmware update status.
- HTML Timestamp: Time stamp for built-in web interface.

3.4.2 Application Configuration

Application Config

Server

Host Name:	<input type="text" value="power-datacenter.com"/>
Port:	<input type="text" value="80"/>
Post URL:	<input type="text" value="/cmmq/dataCenter"/>
Firmware URL:	<input type="text" value="/fw/wifi"/>

Server: Shows the related parameters for data center.

- Host Name: Host name of data server, defaulted at power-datacenter.com
- Port: HTTP server port of data server
- Post URL: Data upload address for the Wi-Fi card
- Firmware URL: Address to verify and download the latest firmware.

Time

SNTP Server1:	<input type="text" value="time.windows.com"/>
SNTP Server2:	<input type="text" value="time-a.nist.gov"/>
SNTP Server3:	<input type="text" value="time.apple.com"/>
Time Zone:	<input type="text" value="UTC+08:00"/>
Daylight saving time:	<input type="text" value="Disable"/>

Time: Shows related parameter to configure SNTP client. Wi-Fi card is built-in with SNTP client. When Wi-Fi card is connected to the internet, it can get time updates through SNTP portocol.

- SNTP Server*: Assign SNTP server address and wifi card will get time updates via this address. Defaulted at time.windows.com.
- Time Zone: Select local time zone and Wi-Fi card will convert the local time based on the time updates from SNTP server.
- Daylight saving time: Select it if local time zone does applied Daylight Saving. The Wi-Fi card will convert the local time based on this setting.

Interval	
Post Data:	<input type="text" value="300"/> Seconds
Firmware Update:	<input type="text" value="24"/> Hours(0 means disable)
<input type="button" value="Apply"/>	

Interval: Working cycles of the Wi-Fi Card.

- Post Data: It's the time interval that the Wi-Fi card uploads information of monitored device to the data server. The setting range is between 30 ~ 3600 seconds and defaulted at 300 seconds.
- Firmware Update: It's the time interval that the Wi-Fi card sync with the update server. The setting range is between 0 ~ 720 hours. The default setting is 24 hours and 0 represents this function being disabled.

Others	
Device ID:	<input type="text" value="WIFICARDTEST001"/> <i>*No changes are recommended</i>
Parallel data collected:	<input type="text" value="Disable"/>
<input type="button" value="Apply"/>	

- Device ID: Serial number of the Wi-Fi Card and it's the only identification means in the data server. Do not modified unless told by the server administrator.
- Parallel data collected: Collect parallel data. Default setting is "Enable".

3.4.3 Network Configuration

Network Config	
Device Role	
Mode:	<input type="text" value="Station"/>
<input type="button" value="Apply"/>	
<i>*The web server will stop, please restart manually.</i>	

- Mode: Two operating modes, Access Point (AP) and Station Mode. The default setting is "Access Point".

***NOTE:** When changing this setting, be sure to restart the Wi-Fi card manually.

Access Point	
SSID:	<input type="text" value="Enter your SSID"/>
Security Type:	<input checked="" type="radio"/> Open <input type="radio"/> WEP <input type="radio"/> WPA
Security Key:	<input type="text" value="Enter your password"/> <i>Hexadecimal digits - any combination of 0-9, a-f and A-F</i>
<input type="button" value="Apply"/>	

- SSID: Enter the SSID under the AP mode. The default SSID is “wificard”.
- Security Type: Select security standard. The default setting is “Open”.
- Security Key: Enter password. The maximum length is 62 digits.

Add Profile	
SSID:	<input type="text" value="Enter your SSID"/>
Security Type:	<input checked="" type="radio"/> Open <input type="radio"/> WEP <input type="radio"/> WPA1 <input type="radio"/> WPA2
Security Key:	<input type="text" value="Enter your password"/> <i>Hexadecimal digits - any combination of 0-9, a-f and A-F</i>
Profile Priority:	<input type="text" value="0"/> <i>Choose a value 0-7 (0 = highest)</i>
<input type="button" value="Add"/>	

Add Profile: Parameter setting under Station Mode. Maximum of 7 profiles could be added.

- SSID: Enter the SSID under Station Mode.
- Security Type: Select security standard. The default setting is “Open”.
- Security Key: Enter password. The maximum length is 62 digits.
- Profile Priority: Set priority of the profile. The range is between 0 – 7. If setting is 0, it’s the first priority.

STA Profiles		
<input type="checkbox"/> 1. bert	Security:WPA	Priority:0
<input type="checkbox"/> 2. -	Security: -	Priority: -
<input type="checkbox"/> 3. -	Security: -	Priority: -
<input type="checkbox"/> 4. -	Security: -	Priority: -
<input type="checkbox"/> 5. -	Security: -	Priority: -
<input type="checkbox"/> 6. -	Security: -	Priority: -
<input type="checkbox"/> 7. -	Security: -	Priority: -
<input type="button" value="Remove"/>		

STA Profiles: Shows all available internet profile. Users can remove individual profile by clicking checkbox and “Remove” button.

Station IP	
DHCP Client:	<input type="radio"/> <i>Disable</i> <input checked="" type="radio"/> <i>Enable</i>
IP Address:	<input type="text" value="0.0.0.0"/>
Subnet Mask:	<input type="text" value="0.0.0.0"/>
Gateway:	<input type="text" value="0.0.0.0"/>
DNS Server:	<input type="text" value="0.0.0.0"/>
<input type="button" value="Apply"/>	

Station IP: Wireless configuration for Station Mode. The default setting is “Enable” for DHCP client. The DHCP Client needs to be “Disable” to manually configure the IP adress, Subnet Mask, Gateway, and DNS server to connect to the data server.

3.4.4 Diagnostic Tools

Ping Test: To help users to check the status of the Wi-Fi card connectivity.

Diagnostic Tools

Ping test

IP Address:	<input type="text" value="Enter your IP address"/>
Packet Size:	<input type="text" value="32"/> bytes (32-1472)
Number Of Pings:	<input type="text" value="4"/>

Ping Result

IP Address:	
Packet Size:	32
Number Of Pings:	4
Total Sent:	0
Successful Sent:	0

4 Monitor

If the Wi-Fi Card operates normally, it will transmit data via wireless network to the data server <http://power-datacenter.com>. Users have to register in order to monitor the operating status and bind the serial number of the monitored device with the registered account.

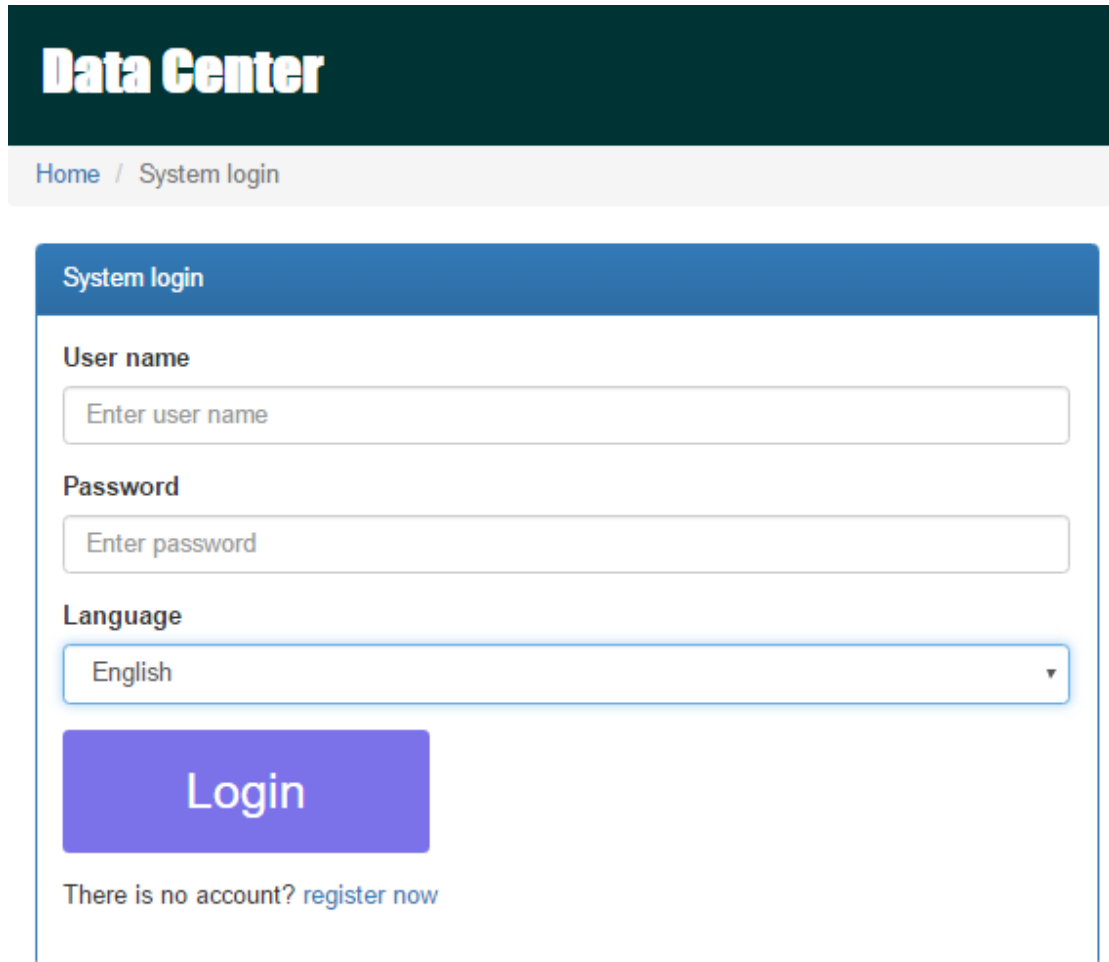

The screenshot shows the 'Data Center' website header in a dark green bar with the text 'Data Center' in white. Below the header is a light grey navigation bar with the text 'Home / System login'. The main content area is a white box with a blue header 'System login'. It contains three input fields: 'User name' with the placeholder 'Enter user name', 'Password' with the placeholder 'Enter password', and 'Language' with a dropdown menu showing 'English'. Below these fields is a large purple 'Login' button. At the bottom of the box, there is a link: 'There is no account? [register now](#)'.

In order to optimize the user's experience, you are suggested to view the information via suggested browser including: Chrome 6+, IE10+, Firefox 4.0+, Safari. As well as smart phones and tablets browsers.

4.1 Registration

1. Click on “register now” below the Login button to start the registration process.

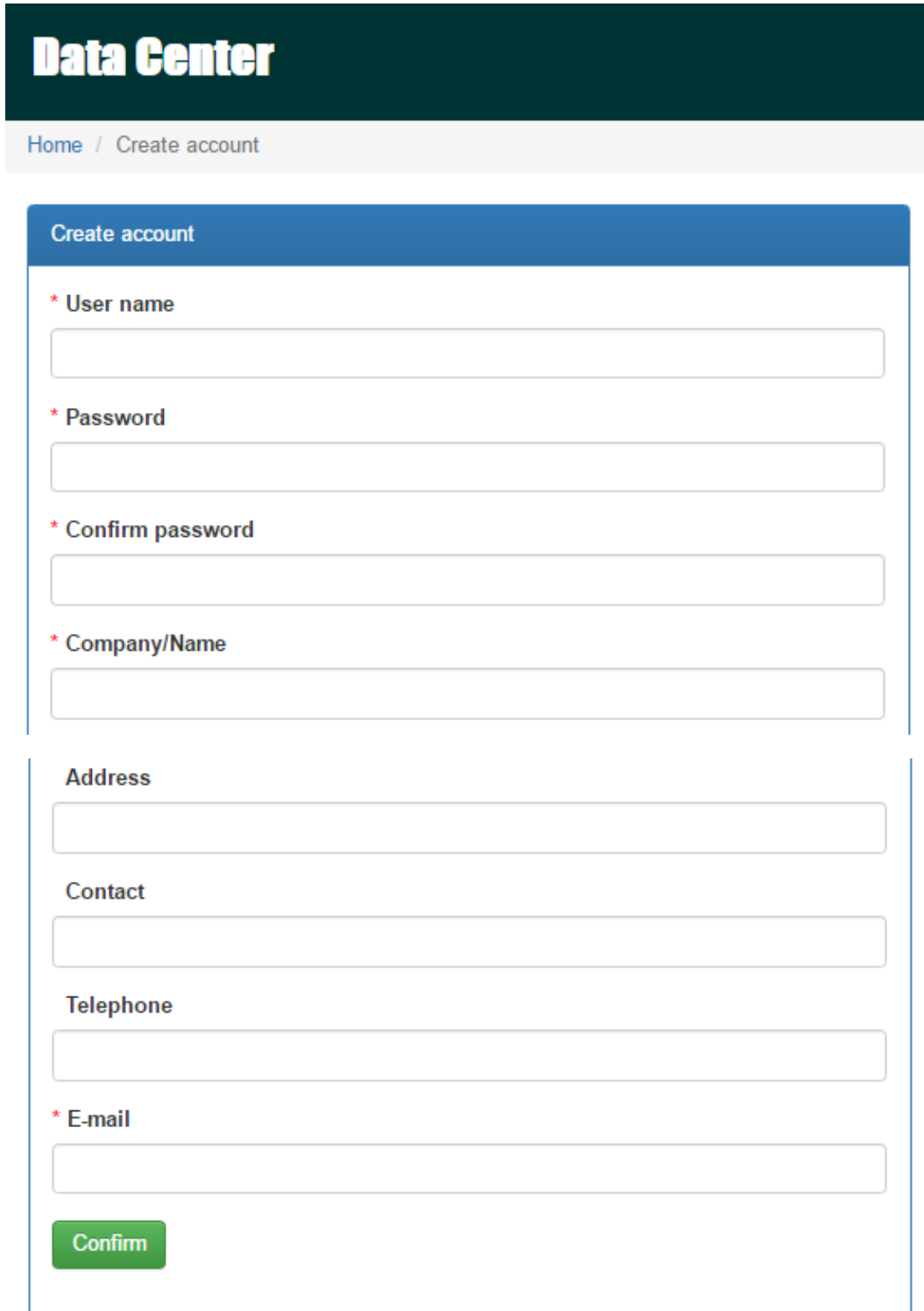

The screenshot shows a web page for a 'Data Center'. At the top, there is a dark green header with the text 'Data Center' in white. Below the header is a light gray navigation bar with the text 'Home / Create account'. The main content area is a registration form titled 'Create account' in a blue header. The form contains several input fields: a required 'User name' field, a required 'Password' field, a required 'Confirm password' field, and a 'Company/Name' field. Below these are three optional fields: 'Address', 'Contact', and 'Telephone'. At the bottom of the form is a required 'E-mail' field and a green 'Confirm' button.

- User name : Please enter user name and remember it for further use.
- Password : It contains 6 ASCII characters, including letters and numbers and it

is case sensitive.

- Confirm password : Re-enter the password from the step above.

2. Click on  button to complete the registration

4.2 Login

After registration, you can log in to the data server. The login page is shown below:

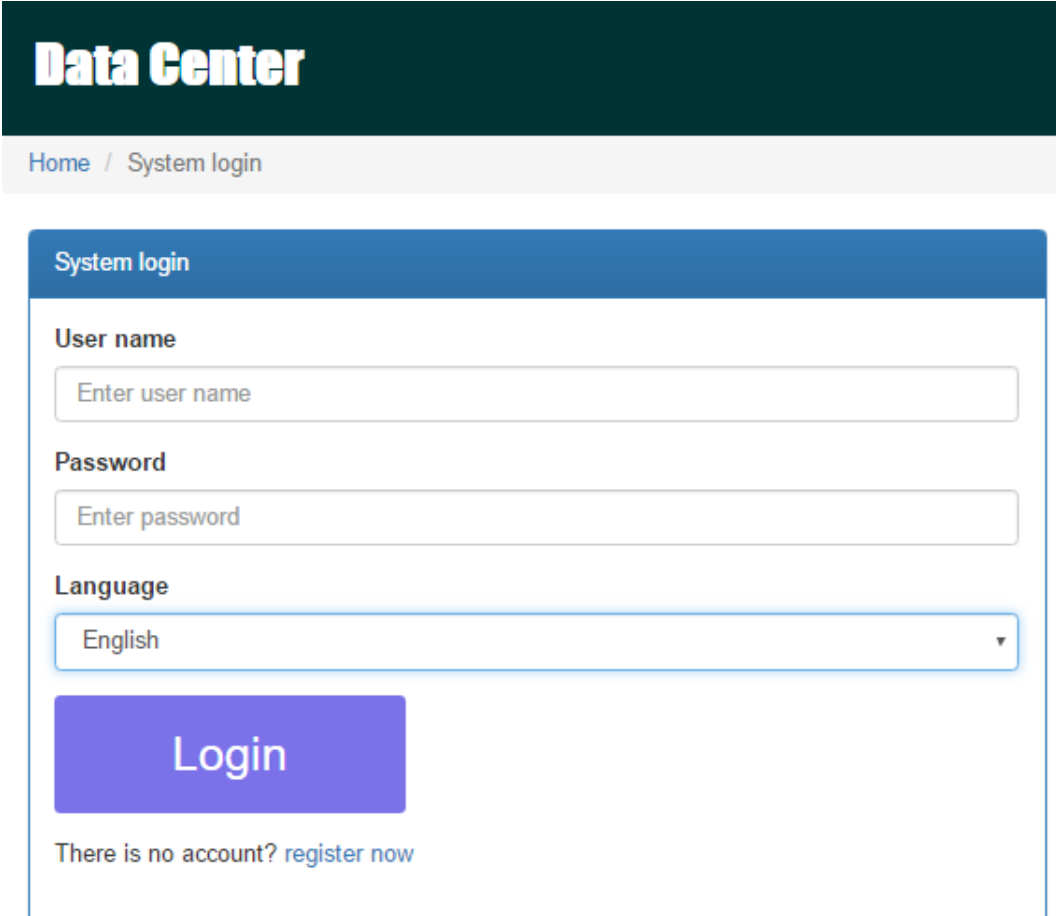

The screenshot shows the 'Data Center' login page. At the top, there is a dark green header with the text 'Data Center' in white. Below the header is a light gray breadcrumb trail: 'Home / System login'. The main content area is a white box with a blue header 'System login'. It contains three input fields: 'User name' with the placeholder 'Enter user name', 'Password' with the placeholder 'Enter password', and 'Language' with a dropdown menu currently set to 'English'. Below these fields is a large purple 'Login' button. At the bottom of the form, there is a link: 'There is no account? [register now](#)'.

After log in, the main page of data server will be shown as illustrated below:

Data Center

Help for GPRS

Location Manager

- Create locations.
- A location should be created before binding.



[Go >>](#)

Device Manager

- Bind the device to a location.
- Assign the device to an end user.



[Go >>](#)

- Location Manager: The users can monitor all device in various locations.
- Device Manager: The users can bind device(s) to designated location and assign to users.

Monitor

- Monitor devices by locations.
- The device should be bound to a location before monitoring.



[Go >>](#)

User Manager

- Create end users.
- End users can login and view the devices also.
- An end user should be created before assignment.



[Go >>](#)

- Monitor: It is grouped by location, and all devices with assigned location will be listed.
- User Manager: Where you create additional users for the account.

4.3 Location Manager

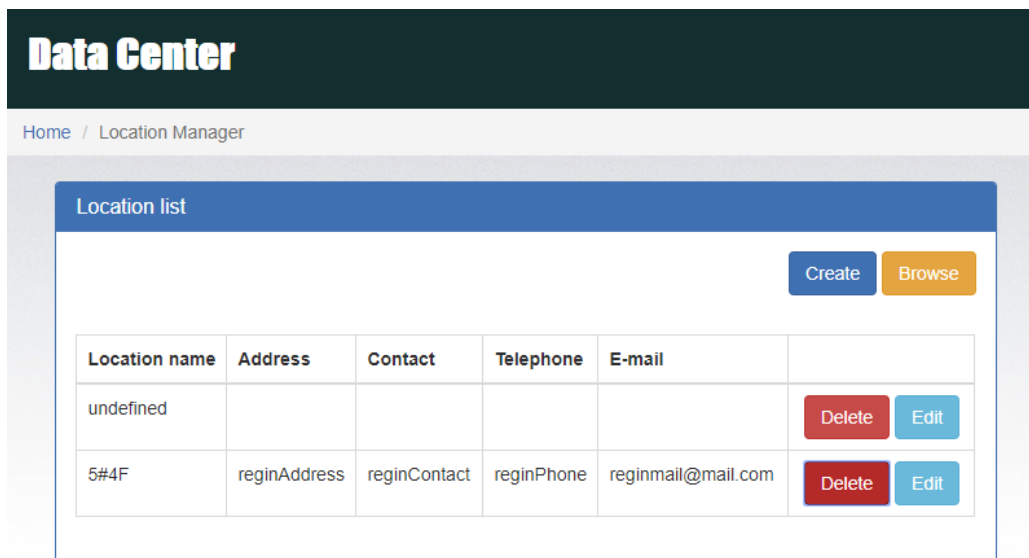

The screenshot shows the 'Data Center' interface with a 'Location Manager' section. It features a 'Location list' table with columns for Location name, Address, Contact, Telephone, and E-mail. There are 'Create' and 'Browse' buttons at the top right of the table. The table contains two rows: one with 'undefined' and another with '5#4F'. Each row has 'Delete' and 'Edit' buttons.

Location name	Address	Contact	Telephone	E-mail	
undefined					Delete Edit
5#4F	reginAddress	reginContact	reginPhone	reginmail@mail.com	Delete Edit

1. Users can create, delete and edit locations.
2. After registration, the system will assigned the user an “undefined” location, which can be deleted or edited.
3. Click on  to start a new location as illustrated below.

Location list

Create Browse

*Location name	<input type="text" value="TestLocation"/>
*Address	<input type="text" value="TestAddress"/>
*Contact	<input type="text" value="TestContact"/>
Telephone	<input type="text" value="1234567890"/>
E-mail	<input type="text" value="test@test.com"/>

Create Close

Location name	Address	Contact	Telephone	E-mail	
undefined					Delete Edit
5#4F	reginAddress	reginContact	reginPhone	reginmail@mail.com	Delete Edit

4. After filling out required fields, click on  to complete the new location.

5. Click on  to terminate creation.

4.4 Device Manager

The screenshot shows a web interface for the Device Manager. At the top, there are two tabs: 'Bind device' and 'Assign device'. The 'Assign device' tab is active. Below the tabs is a form with four input fields: 'Device' (text input with value '92931312100028'), 'Device name' (text input with value 'Inverter 5KVA'), 'Device type' (dropdown menu with value 'Hybrid Inverter'), and 'Location name' (dropdown menu with value '5#4F'). Below the form are two buttons: 'Browse' (orange) and 'Bind' (blue). Below the buttons is a blue bar with the text 'List'.

1. Bind Device: Assign device to the location.

- Device: Fill in the serial numbers of the monitored device. (Serial number label is on the monitored device).
- Device name: Assign a name so that the users can directly identify which card or device it is.
- Device type: Select the type of monitoring device.
- Location name: Select the bound location of monitored device.

Click  to complete the assignment.

Click  to list the information of bound device.

2. Assign device

Please refer to section 3.6 under User management for detail instruction.

4.5 Monitor

Location : TestLocation

Card ID	12344678
SN	55355535553555

WIFI √

2016/11/15 09:51:48 0 minutes ago

PV input power	0	W
Grid voltage	0	V
Battery capacity	100	%

[Browse](#) [Delete](#)

Location : TestLocation2

1. It's grouped by locations, and all device in that location will be listed.
2. The message will be updated once every 5 minutes.
3. Click on [Browse](#) to show detail information on a new page.

[Close](#)

Monitor ☰

Status

Data

Event log

- Click on [Close](#) to close the window.

- Status: Current operational status of the monitored device.
- Status Display:

It shows the status of the monitored device in a graphical representation. The serial number is shown on the top of the window and operational status indicator is shown as a color dot to the right.

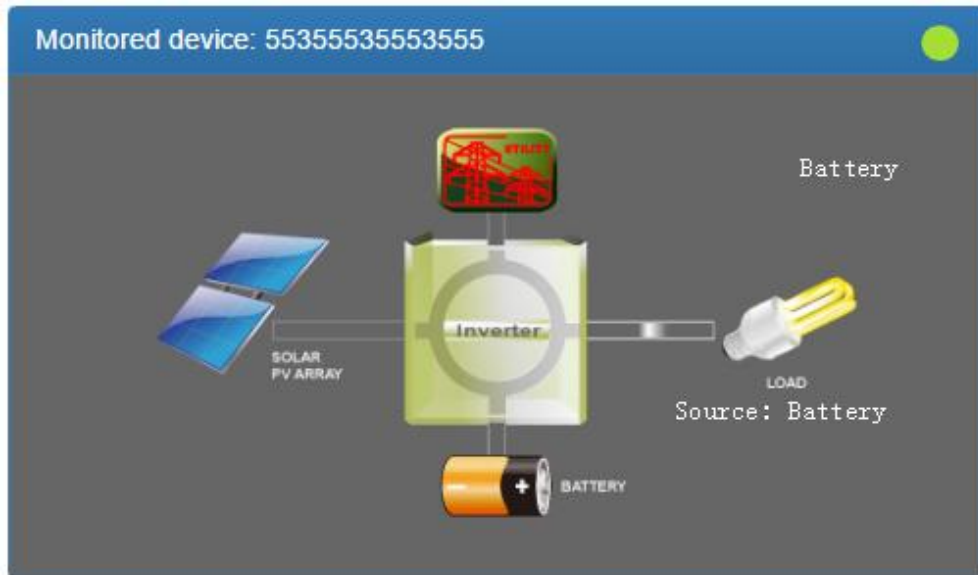

- a) Basic information:
It displays basic information including the voltage, current, loading, temperature, etc.

Basic information		
PV input voltage	<input type="text" value="0"/>	V
Battery voltage	<input type="text" value="55.6"/>	V
Charging current	<input type="text" value="0.0"/>	A
Grid voltage	<input type="text" value="0"/>	V
Grid output voltage	<input type="text" value="230"/>	V
AC output apparent power	<input type="text" value="0"/>	VA
Output load percent	<input type="text" value="0"/>	%
Total AC output apparent power	<input type="text" value="0"/>	VA
Total output load percent	<input type="text" value="0"/>	%

- b) Power Information:
It displays power generation statistics separated into “per hour,” “Daily,” “Monthly,” “Annual” basis.

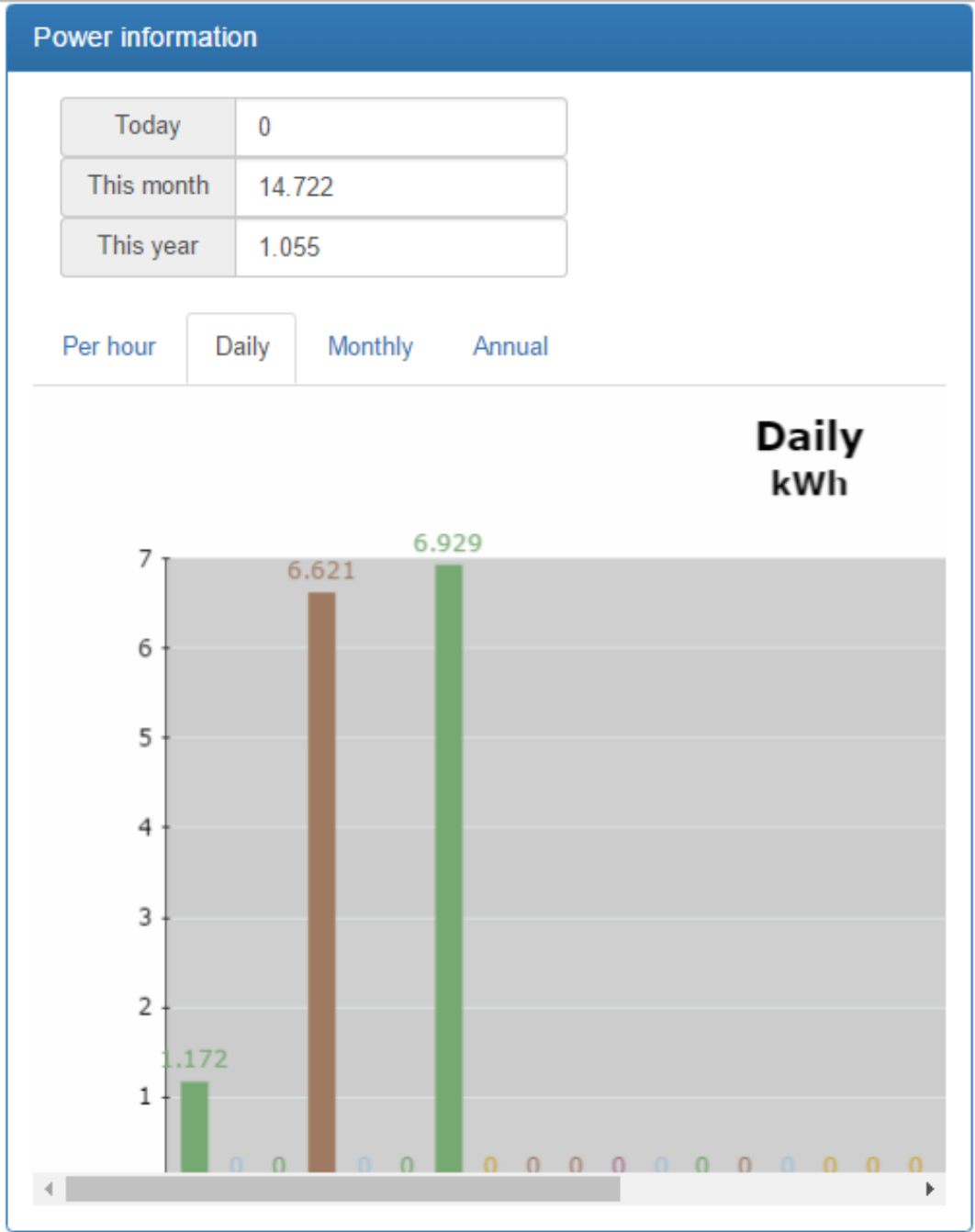

- c) Rated information:
 It shows the nominal rated information including input voltage, output voltage, frequency, battery voltage, etc.

Rated information			
Nominal AC voltage	<input type="text" value="230"/>		V
Nominal output voltage	<input type="text" value="230"/>		V
Nominal output frequency	<input type="text" value="50"/>		Hz
Nominal output apparent power	<input type="text" value="5000"/>		VA
Nominal AC current	<input type="text" value="21.7"/>		A
Nominal output current	<input type="text" value="21.7"/>		A
Nominal output active power	<input type="text" value="4000"/>		W
Rated battery voltage	<input type="text" value="48"/>		V

d) Product Information

It shows the product information including model type, Main CPU processor version, voltage, etc.

Product information			
Model type	<input type="text" value="Stand alone"/>		
Main CPU processor version	<input type="text" value="00012.30"/>		
Topology	<input type="text" value="Transformerless"/>		
Secondary CPU processor version	<input type="text" value="00000.00"/>		

- Data: Historical data of currently monitored device.

		Begin time	End time
Year	<input type="text" value="2016"/>	<input type="text" value="2016/11/15"/>	<input type="text" value="2016/11/15"/>
Per page	<input type="text" value="15"/>	<input type="text" value="00:00"/>	<input type="text" value="23:59"/>
			<input type="button" value="Browse"/>

	Device mode	Time	PV input voltage	PV input power	Grid voltage	Grid frequency	Battery voltage	Bat capacity
1	Battery	2016/11/15 09:56:57	0.0	0	0.0	0.0	55.6	10
2	Battery	2016/11/15 09:51:48	0.0	0	0.0	0.0	55.6	10
3	Battery	2016/11/15 09:46:45	0.0	0	0.0	0.0	55.5	10

➤ Event log: Historical events of currently monitored device.

		Begin time	End time
Year	<input type="text" value="2016"/>	<input type="text" value="2016/11/15"/>	<input type="text" value="2016/11/15"/>
Per page	<input type="text" value="15"/>	<input type="text" value="00:00"/>	<input type="text" value="23:59"/>
			<input type="button" value="Browse"/>

	Level	Time	Event	
1		2016/11/15 09:46:45	LINE_FAIL	<input type="button" value="Delete"/>

➤ Power generation data log: Power generation data of currently monitored device.

Period NO.	Year ▾
<input type="button" value="Browse"/> <input type="button" value="Delete"/>	

Time	Output power
2016/11/01	1.172
2016/11/02	0.0
2016/11/03	0.0
2016/11/04	6.621
2016/11/05	0.0
2016/11/06	0.0

4.6 User Manager

Users can create additional logins and assign specific Wi-Fi card to a particular login. The end-user can monitor the device by logging into the data server via assigned Wi-Fi cards.

1. Create User

User list

User name	Company/Name	Address	Contact	Telephone	E-mail	Role	Creat time
There are no records.							

- Click on to show the login creation window.

User list

Create Browse

*User name	end-user
Role	View ▼
*Password	
* Company/Name	end-user-company
Address	end-user-address
Contact	end-user-contact
Telephone	end-user-tel
*E-mail	end-user-email
Create Close	

- After filling in the required fields, click on **Create** to complete the operation.

User list								
							Create	Browse
Company/Name	Address	Contact	Telephone	E-mail	Role	Create time		
end-user-company	end-user-address	end-user-contact	end-user-tel	end-user-email	View	2016/11/14 21:32:46	Delete	

- Click on [Close](#) to end the creation process.
- Click on [Delete](#) to remove existing user(s).

2. Assign device

The Wi-Fi card can be assigned to specific end-user/login.

Bind device	Assign device		
Device type	<input type="text"/>	Location name	<input type="text"/>
Device	<input type="text" value="96121609100001"/>	End user	<input type="text"/>
		Browse	Assign
List			

Device type/ Location name: The pull-down value may vary depending on different devices.

Device: Select Device.

End user: Select one of the end-users.

Click on [Assign](#) to complete the assignment:

Bind device Assign device

Device type Hybrid Inverter Location name 5#4F

Device 96121609100001 End user end-user-commpany

Browse Assign

List

#	Device	Device name	Type	Location name	End user	
1	96121609100001	infini v	Hybrid Inverter	5#4F	end-user	unassign

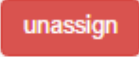
Click on  to unbind the Wi-Fi card assignment.

4.7 Email Notification

Users can set up e-mail notification when warning or faults of any kind occurred in the inverter. Data server will send alarm notification(s) to specific e-mail addresses. Click on the pull-down indicator on the upper right-hand corner of the screen to begin.

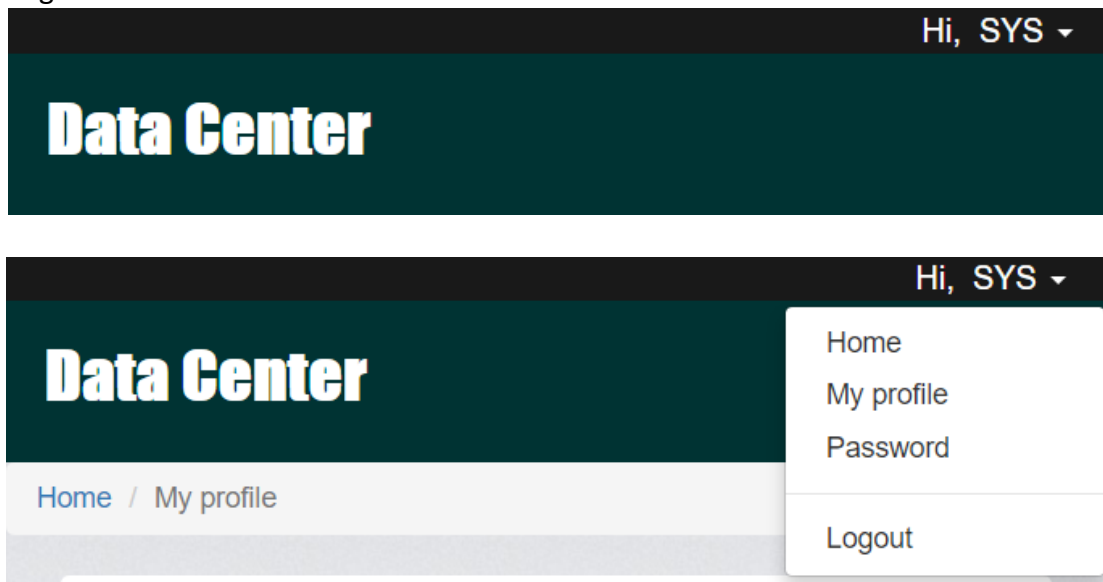

Select "My profile"

It will prompt you with the following screen and please enter the email address of intended receiver. Check "Email notification" box and then click on  to

confirm your input.

E-mail

Email notification

Create time 2016/09/02 01:45:13

Update

5 Trouble Shooting

If you have trouble with any of the step above, please consult with the flow-chart below to troubleshoot the Wi-Fi card.

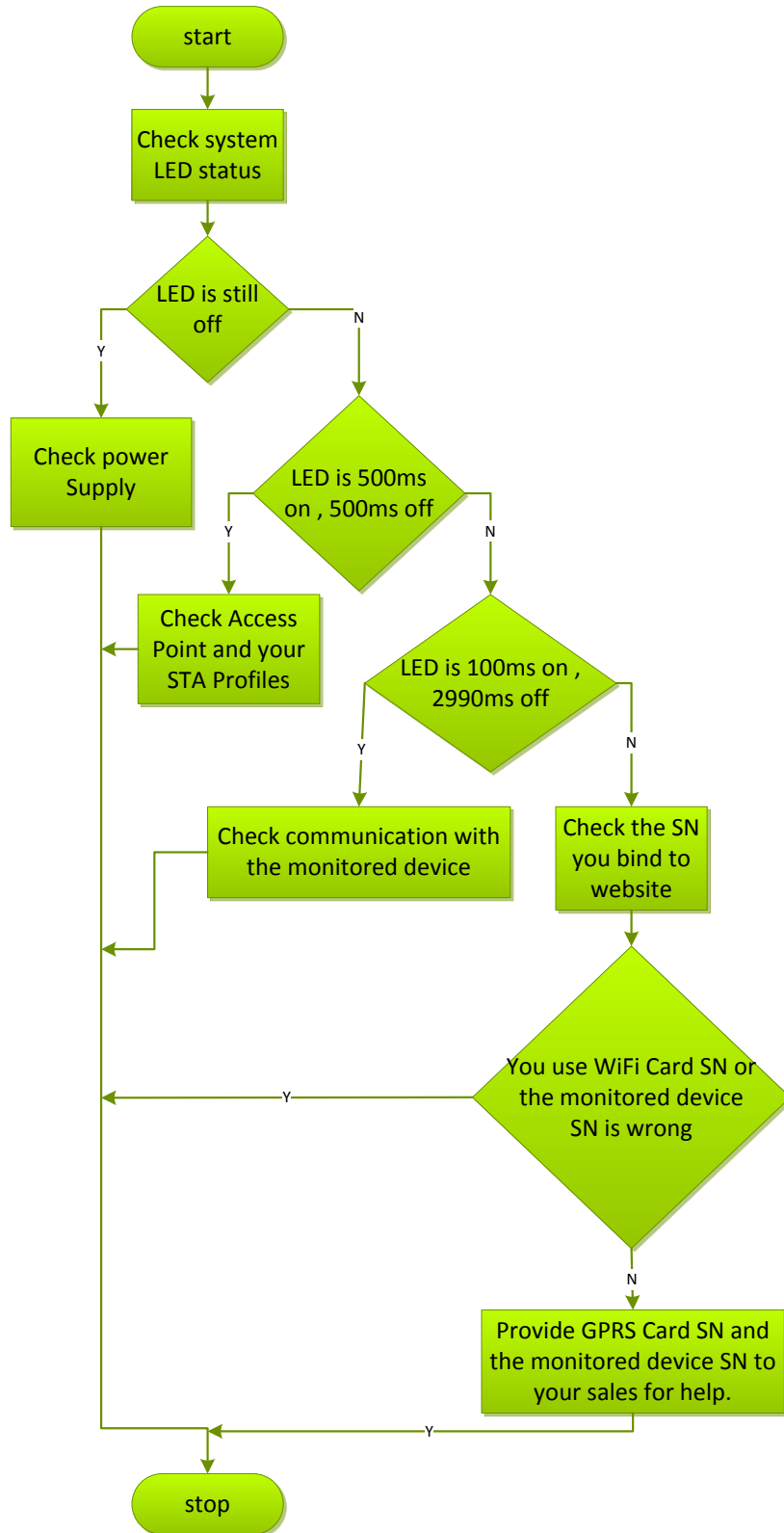

5.1 Frequently Asked Questions

- **Question 1:** WiFi Card can not be set up in STA(Station) mode.
Solution: Be sure that UC2 pin is in “1,2” position and at least one effective STA(Station) Profile is created or present.
- **Question 2:** Device Time is not correct in the data server.
Solution: If monitored device is equipped with RTC (real-time clock), Wi-Fi card will apply local device time setting. Please be sure that the time setting in the monitored unit is correct. Otherwise, Wi-Fi card will apply time information via SNTP protocol.